

Automobile Working on Addition of HHO Fuel to Improve the Efficiency of IC Engine

Saroj Kumar Pradha¹, Sasmita Tripathy²

¹ Department of Mechanical Engineering ,Gandhi Engineering College , Odisha , India
² Department of Mechanical Engineering ,Gandhi Institute For Technology , Odisha , India

ABSTRACT: In this paper we have studied the basic properties of gas generated through electrolysis of H₂O & then used gas in the bike as a fuel with gasoline by mixing it with air. This results the increased mileage of bike 30 to 60% & reduce the polluting contents from the exhaust gases. Hydrogen gas combined with the standard air/fuel mixture increases the mileage. This form of alternative fuel is provided by a hydrogen generator mounted in the vehicle. Once set up is ready, the hydrogen gas will be produced from water, an electrolyte compound, and electricity supplied from a battery provided. Here we are designing a mixed fuel two wheeler engine. Ie in conventional SI engine we are incorporating traces of hydrogen along with gasoline in order to minimum consumption of gasoline as well as to increase the power of vehicle. Here in addition, a hydrogen generating unit is made to produce hydrogen.. It is actually an electrolysis unit having high grade stainless steel/graphite/semiconductors as electrodes in a closed container and mixture of distilled H₂O & suitable ionic solution (KOH or NaOH) as electrolyte. Power for electrolysis is taken from an additional battery provided (12 V). This battery can be recharged from a dynamo/alternator/motor provided on the vehicle.

KEYWORDS: KAOH, NaOH, SI engine, electrolysis of H₂O, Hydrogen cell.

I. INTRODUCTION

Multifuel, sometimes spelled multi-fuel is any type of engine, boiler, heater or other fuel-burning device which is designed to burn multiple types of fuels in its operation. One common application of multifuel technology is in military settings, where the normally-used diesel or gas turbine fuel might not be available during combat operations for vehicles or heating units. Multifuel engines and boilers have a long history, but the growing need to establish fuel sources other than petroleum for transporting and heating and other uses has led to increased development of multifuel technology for non-military use as well, leading to many flexible-fuel vehicle designs in recent decades. A multifuel engine is constructed so that its compression ratio permits firing the lowest octane fuel of the various accepted alternative fuels. A strengthening of the engine is necessary in order to meet these higher demands. Multifuel engines sometimes have switch settings that are set manually to take different octane, or types, of fuel. Many other types of engines and other heat-generating machinery are designed to burn more than one type of fuel. For instance, some heaters and boilers designed for home use can burn wood, pellets, and other fuel sources. These offer fuel flexibility and security, but are more expensive than are standard single fuel engines.^[7] Portable stoves are sometimes designed with multifuel functionality, in order to burn whatever fuel is found during an outing.^[8] Multifuel engines are not necessarily underpowered, but in practice some engines have had issues with power due to design compromises necessary to burn multiple types of fuel in the same engine. Perhaps the most notorious example from a military perspective is the L60 engine used by the British Chieftain Main Battle Tank, which resulted in a very sluggish performance in fact, the Mark I Chieftain (used only for training and similar activities) was so underpowered that some were incapable of mounting a tank transporter. An equally serious issue was that changing from one fuel to another often required hours of preparation.^[9] The US LD series had a power output comparable to commercial diesels of the time. It was underpowered for the 5-ton trucks, but that was the engine size itself, the replacement diesel was much larger and more powerful. The LD engines did burn diesel fuel poorly and were very smokey, the final LDT-465 model had a turbocharger largely to clean up the exhaust, there was little power increase. Rivaz (1807) of Switzerland invented an internal combustion engine with electric ignition which used the mixture of hydrogen and oxygen as fuel. He designed a car for his engine. On the application of hydrogen gas to produce a moving power in machinery; with a description of an engine which is moved by pressure of the atmosphere upon a vacuum caused by explosion of hydrogen gas and atmospheric air. "In this document, he explained how to use the energy of hydrogen to power an engine and how the hydrogen engine could be built. This is probably one of the most primitive inventions made in hydrogen-fueled engines.

II. THEORY

The oxygen enriched air or the nitrogen enriched air becomes mixed with the ambient air in the mixing chamber and then the mixed air is supplied to the intake of the engine. As a result, the air being supplied to the

intake of the engine can be regulated with respect to the concentration of oxygen and/or nitrogen. A decrease in the undesirable emissions that are present in the exhaust of the internal combustion engine was resulted from the above invention.

Wartinbee, Jr. (1971) conducted the emission study to determine the effects of oxygen enriched air on exhaust emissions. Compared to operation with lean air-fuel mixtures, the results indicated that hydrocarbon emissions were reduced substantially.

Gerry and Martin (1973) filed an application for the patent right for pure oxygen supply to an internal combustion engine. Considerable decreases in hydrocarbons and oxides of nitrogen from the exhaust system of an internal combustion engine were obtained.

JamilGhojel et al (1983) has undergone a study on Effect of Oxygen Enrichment on the Performance and Emissions of I.D.I. Diesel Engines and investigated effect of the partial pressure of O₂ in the intake charge of an I.D.I. Diesel engine on the various operating parameters and the exhaust emissions. The oxygen content in the intake was varied between 21% and 40% by volume. Engine performance and emissions were evaluated at a constant engine speed and injection timing while fueling was varied. The research revealed that enriching the intake air with oxygen led to a large decrease in ignition delay and reduced combustion noise. The fuel economy, the power output and the exhaust temperature remained almost constant. HC and CO emissions decreased and smoke levels dropped substantially, while NO_x emissions increased pro-rata with the O₂ added. Norimasa Iida et al (1986) has done the experimental effects of Intake Oxygen Concentration on the Characteristics of Particulate Emissions from a D.I. Diesel Engine. It was found that OEC reduces particulate emissions from a DI diesel engine for all operating conditions tested.

Watson et al (1990) introduced a method of operating a diesel or spark ignition engine which includes enriching the combustion air supply with oxygen while simultaneously adjusting the fuel injection or ignition timing of the engine to compensate for advanced combustion caused by increased oxygen content in the combustion air.

Combustion of Hydrogen with Gasoline

Stebar & Parks (1974) investigated about the hydrogen supplementation by means of extending lean operating limits of gasoline engines to control the NO_x emissions. They carried out their test in a single cylinder engine. Their results showed that small additions of hydrogen to the fuel resulted in very low NO_x and CO emissions for hydrogen-isooctane mixtures leaner than 0.55 equivalence ratio.

Houseman & Hoehn (1974) presented the first engine dynamometer test results for a modified fuel system based on hydrogen enrichment for a V-8 IC engine. The engine burnt mixtures of gasoline and hydrogen under ultra lean conditions and yielded extremely low NO_x emissions with increased engine efficiency.

Rose (1995) made researches on the method and apparatus for enhancing combustion in an ICE through electrolysis and produced hydrogen along with oxygen yielded enhanced combustion at low engine loads for all types of engines.

Combustion of Hydrogen with LPG

Lata et al (2012) conducted an experimental investigation on performance & emission of a dual fuel operation of a 4 cylinder, turbocharged, intercooled, 62.5 kw genset diesel engine with H₂ & LPG. The mixture of LPG & H₂ as secondary fuel, carried out the experiment at wide range of load condition of the engine with different 54 gaseous fuel substitutions. When only hydrogen was used as secondary fuel, the maximum enhancement in the brake thermal efficiency was 17% which was obtained with 30% of secondary fuel, while compare with the LPG as a secondary fuel with brake thermal efficiency was 6% & 40% of secondary fuel. They observed that compared to the pure diesel operation, proportion of unburnt HC and CO got increased while emission of NO_x and smoke got reduced in both cases. When 40% of the mixture of LPG and H₂ was used in the ratio of 70:30 as secondary fuel, brake thermal efficiency got enhanced by 27% and HC emission got reduced by 68%.

Rao et al (2008) performed experiments on a conventional diesel engine operating on dual-fuel mode using diesel and LPG at a constant speed of 1500 rpm and under varying load conditions. The brake power of the engine was about 15% more & specific fuel consumption was 30% lower than diesel fuel.

Qi et al (2007) conducted an experimental investigation on a single cylinder direct injection diesel engine modified to operate in dual fuel mode with diesel-LPG as fuels. They used various rates of LPG diesel blends for their experiments. They compressed LPG of 0, 10, 20, 30, and 40% by pressured nitrogen gas to mix with the diesel fuel in a liquid form. They concluded that LPG-diesel blended fuel combustion was a promising technique for controlling both NO_x and smoke emissions even on existing DI diesel engines.

Rao et al (2008) performed experiments on a conventional diesel engine operating on dual-fuel mode using diesel and LPG at a constant speed of 1500 rpm and under varying load conditions. The brake power of the engine was about 15% more & specific fuel consumption was 30% lower than diesel fuel.

Qi et al (2007) conducted an experimental investigation on a single cylinder direct injection diesel

engine modified to operate in dual fuel mode with diesel-LPG as fuels. They used various rates of LPG diesel blends for their experiments. They compressed LPG of 0, 10, 20, 30, and 40% by pressured nitrogen gas to mix with the diesel fuel in a liquid form. They concluded that LPG-diesel blended fuel combustion was a promising technique for controlling both NOX and smoke emissions even on existing DI diesel engines.

III. METHODOLOGY

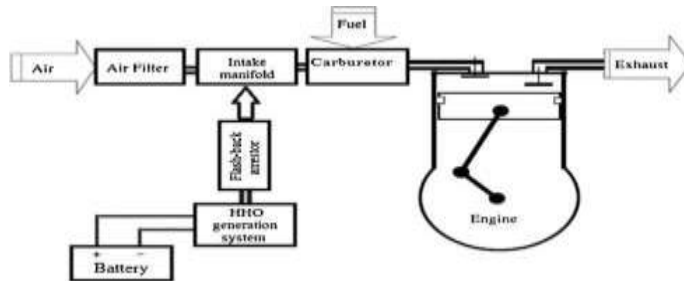

Fig 1

In the above block diagram shown, the air enters the air filter wherein the dust particles present in the air is filtered and then sent to the carburetor. In the carburetor the air gets mixed with the fuel viz. petrol/LPG. A connection of HHO generation system to which the battery is connected is installed and connected as shown in the above fig 1.

In the HHO generator the water is split by electrolysis process with the 12V battery supply. Caustic soda is used as a catalyst to speed up the process. The hydrogen molecule gets mixed with the petrol/LPG and is sent to the combustion chamber.

IV. EXPERIMENTAL SETUP

GasTank



Fig 2

The most critical aspect of an LPG conversion is choosing the size of tank that will fit in your boot. Remember LPG is a heavy gas, and in case of leakage it will settle around the vehicle increasing risk of a fire, and hence it is important to get a proper branded tank that's securely installed. There are two kinds of tanks available – the cylindrical tank and the toroid tank. The latter fits in the spare wheel well of the boot of the vehicle, but does not have much capacity. The cylindrical tanks come in 5-litre capacity. The choice of tank will depend on how much space you have in your boot.

Refillingpoint



Fig 3

Most LPG systems usually have the refilling point located close to the storage cylinder, unlike CNG systems that have it in the engine bay mostly. This is a pin type pressure valve that can take an LPG nozzle (similar to what you see on your domestic LPG cylinders, but smaller).

Multi valve and as levelindicator



Fig 4

The solenoid valve is the next component in the system. This is basically a “tap” that switches on or off the flow of gas from the storage cylinder to the engine. It takes its commands from the changeover switch.

Changeoverswitch



The changeover switch is located in the cabin for the driver to operate. It switches between petrol and gas. When the vehicle is operating on gas alone, this changeover switch will deactivate the petrol fuel pump, shutting off petrol supply to the engine, allowing only gas and vice versa. Changeover switches also act as a gas-fuel gauge by indicating the level of gas in the tank.

Regulator or vaporizer



Fig 6

The vaporizer is the heart of the system. It is responsible for converting liquid LPG into gas. It uses heat generated from the engine coolant for this. The regulator is a bulky unit that sends gas to the injectors.

V. BLOCK DIAGRAM OF HHOKIT

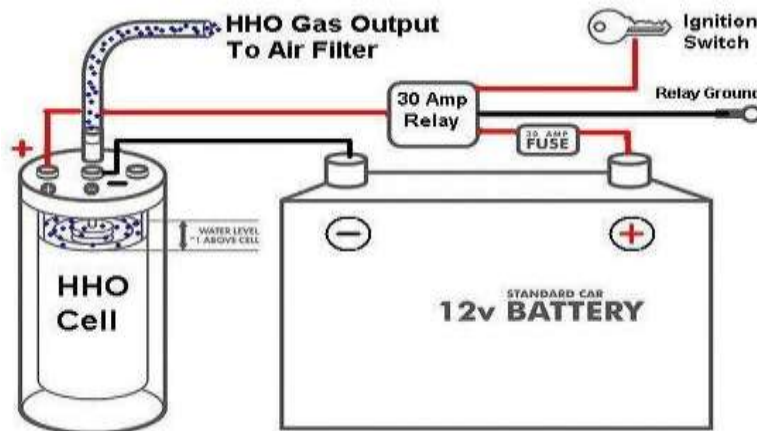

Fig 7

This is supposed to be an efficient way to convert ordinary tap water into gaseous hydrogen and oxygen and then burn this vapour in the engine along with petrol/LPG. This mini system runs easily from your existing battery and electrical system and plugs it into your air intake with simple fittings. HHO kit consists of HHO cell which consists stainless steel plates. One side is connected to the positive terminal and the other to the negative terminal of the battery. It is supplied with the current as shown in the fig. The gas produced by the process of electrolysis is supplied to carburetor via airfilter.

Working of HHO kit

HHO gas is a unique product based on the discoveries and patent work of Professor Yull Brown in the late 1960's. He discovered (in contradiction to the conventional wisdom of the time), that it was indeed possible to create a unique electrolyser that could separate the hydrogen and oxygen atoms out of water, without separating them into different tanks. Prior to this, the common misconception by experts, was that the hydrogen and oxygen should never be allowed to join together after electrolysis).

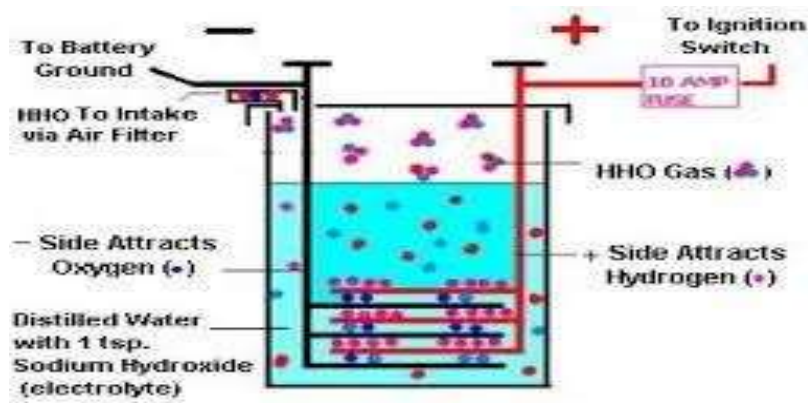

Fig 8

Our **HHO kits** electrolyze the hydrogen and oxygen atoms directly out of the water, without separating them, creating a unique and energetic form of gas containing H, O, H₂, O₂, and even H₂O. The gas is filtered, then injected into the air intake of the vehicle, where it mixes along with the air and gasoline (petrol) or diesel fuel of the car.

The hydrogen-oxygen gases blend with the normal fuel inside the engine, and upon combustion, rapidly ignite acting as a "**combustion catalyst**", making the fuel burn faster, more thoroughly, and much cleaner. The HHO gas upon exploding, simply reverts back into water in microseconds, which then turns into superheated steam, cleaning the inside of the engine of carbon deposits and sludge.

Since the gas causes the existing fuel to burn faster and more complete, there is less waste, and the energy is extracted where it matters most- inside the engine. This is why it results in extra mileage, better engine response, and lower emissions- by increasing combustion efficiencies.

Reaction

A pure stoichiometric mixture may be obtained by water electrolysis, which uses an electric current to dissociate the water molecules:

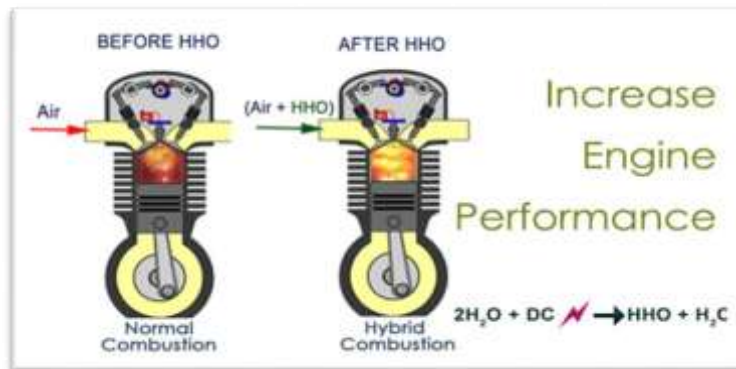
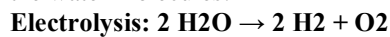

Fig 9

It is clear from the above figure that using HHO kit greatly influences the combustion. It helps in complete combustion, increasing the mileage and reducing the emissions.

Work Carried out



Fig 10

VI. RESULTS AND DISCUSSION

	PRESCRIBED STANDARD	MEASURED VALUE (AFTER HHO)	MEASURED VALUE (BEFORE HHO)
CO (% vol)	4.5	1.189	2.160
HC (PPM)	9000	1956	2742
CO ₂ (% vol)	---	1.96	3.35
O ₂ (PPM)	---	10.21	13.70

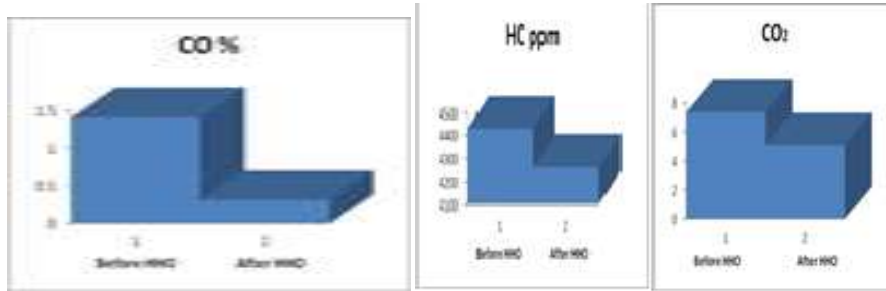

Graph(i) Graph(ii) Graph(iii)

VI.1.1 Discussion

- The (i) graph which depicts the value of CO % before the HHO kit and after the installation of the HHO kit clearly indicates that the emissions has been decreased drastically which indicates that the combustion is complete.
- The (ii) graph which depicts the value of HC before the HHO kit and after the installation of the HHO kit clearly indicates that the emissions has been decreased drastically which indicates that the combustion is complete. The decrease in the HC level indicates that the mileage has been increased as well as the performance.
- The (iii) graph which depicts the value of CO₂ before the HHO kit and after the installation of the HHO kit clearly indicates that the emissions has been decreased drastically which indicates that the combustion is complete. The decrease in the CO₂ level tells that the emission is eco-friendly.

for LPG

	PRESCRIBED STANDARD	MEASURED VALUE (After HHO)	MEASURED VALUE (Before HHO)
CO (% vol)	4.5	0.312	1.412
HC (PPM)	4500	4261	4431
CO ₂ (% vol)	---	5.10	7.40
O ₂ (PPM)	---	11.99	13.40

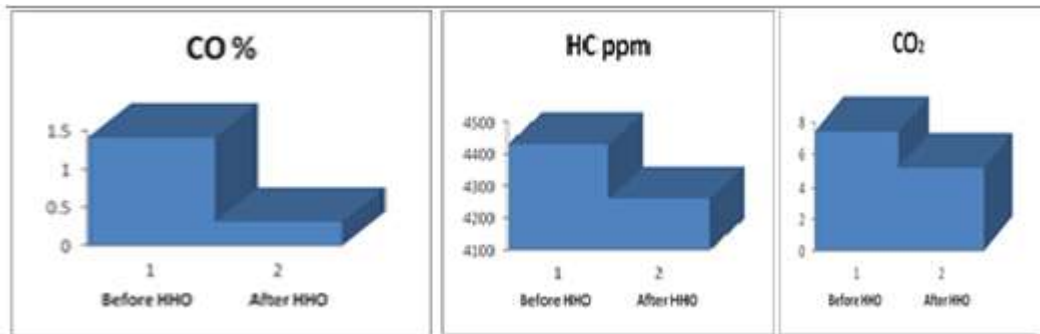

Graph(i) Graph(ii) Graph(iii)

Discussion

- The (i) graph which depicts the value of CO % before the HHO kit and after the installation of the HHO kit clearly indicates that the emissions has been decreased drastically which indicates that the combustion is complete.
- The (ii) graph which depicts the value of HC before the HHO kit and after the installation of the HHO kit clearly indicates that the emissions has been decreased drastically which indicates that the combustion is complete. The decrease in the HC level indicates that the mileage has been increased as well as the performance.
- The (iii) graph which depicts the value of CO₂ before the HHO kit and after the installation of the HHO kit clearly indicates that the emissions has been decreased drastically which indicates that the combustion is complete. The decrease in the CO₂ level tells that the emission is eco-friendly.

VII. ADVANTAGE OF MULTI-FUEL AUTOMOBILE

- The fuel used that is LPG is cheaper.
- The combustion is complete where there is complete utilization of the fuels.
- Hence the spark plug life also increases.
- The storage of fuels in tank is very easy as it can be stored either in small or large tanks.
- The shelf life and the density of fuels used is lighter which makes added advantage.
- The process of using mixture of hydrogen and fuel leads to improve in fuel economy, power output, and emissions
- Increase in life of engine oil more than 2 to 3 times.
- Our engine will add oxygen to the environment instead of polluting it.

Disadvantage of Multi-fuel automobile

- The major disadvantage is highly inflammable and under pressure may be very dangerous.
- The automobile may be heavy because of the presence of two fuel tanks.
- The installation costs for extra fuel tank and the HHO Kit may be costly

Application of Multi-fuel automobile

- Its major application is in military vehicles.
- It can also be used in commercial as well as passenger vehicles.

VIII. CONCLUSION

HHO fuel cell has been performed to HHO gas required for engine operation. The generated gas is mixed with a fresh air in the intake manifold. The exhaust gas concentrations have been sampled and measured using a gas analyzer. The following conclusions can be drawn.

1. HHO cell can be integrated easily with existing engine systems.
2. The engine thermal efficiency has been increased up to 10% when HHO gas has been introduced into the air/fuel mixture, consequently reducing fuel consumption up to 34%.
3. The concentration of NO_x, CO and HC gases has been reduced to almost 15%, 18% and 14% respectively on average when HHO is introduced into the system.
4. The best available catalyst was found to be NaOH, with concentration 6g/L.
5. The proposed design for separation tank takes into consideration the safety precautions needed when dealing with hydrogen fuel.

It is recommended for the future work to study the effect of both compression ratio and ignition advance on the engine performance and emissions with introducing HHO gas into the gasoline engine.

REFERENCES

- [1]. NASA Technical Note, May 1977, "Emissions and Total Energy Consumption of a Multicylinder Piston Engine Running on Gasoline and a Hydrogen-Gasoline Mixture" (Accessed 2008-08-08)
- [2]. Hydrogen Internal Combustion Engine Vehicles Idaho National Laboratory.
- [3]. G. Fontana, E. Galloni, E. Jannelli and M. Minutillo (January 2002). "Performance and Fuel Consumption Estimation of a Hydrogen Enriched Gasoline Engine at Part-Load Operation". SAE Technical Paper Series (2002-01-2196):4-5.
- [4]. Mathur H.B., Das L.M. (1991). "Performance characteristics of a Hydrogen Fueled SI Engine using Timed Manifold Injection". Int. J. Hydrogen Energy (vol 16, pp. 115-117, 1991).
- [5]. Per Tunestal, Magnus Christensen, Patrik Einewall, Tobias Anderson, and Bengt Johansson (January 2002). "Hydrogen Addition for Improved Lean Burn Capability of Slow and Fast Natural Gas Combustion Chambers". SAE Technical Paper Series (2002-01-2686): 7-8.
- [6]. Tsolakis A, Megacities A, Wyszynski ML, "Application of exhaust gas fuel reforming in compression ignition engines fueled by diesel and biodiesel fuel mixtures" Energy & Fuels 17 (6): 1464-1473 NOV-DEC 2003.
- [7]. Yougen Kong, Sam Crane, Palak Patel and Bill Taylor (January 2004). "NOx Trap Regeneration with an On-Board Hydrogen Generation Device". SAE Technical Paper Series (2004-01-0582): 6-7.
- [8]. Thorsten Allgeier, Martin Klenk and Tilo Landefeld (January 2004). "Advanced Emissions and Fuel Economy Control Using Combined Injection of Gasoline and Hydrogen in SI-Engines". SAE Technical Paper Series (2004-01-1270):11-12.
- [9]. abWater-Powered Cars: Hydrogen Electrolyzer Mod Can't Up MPGs, Mike Allen, August 7, 2008, Popularmechanics.com [10]. See list of devices tested under EPA Gas Saving and Emission Reduction Devices Evaluation
- [10]. US Environmental Protection Agency, "Devices and Additives to Improve Fuel Economy and Reduce Pollution - Do They Really Work?"
- [11]. Barton, P.J. 2004. Study of Heavy Duty Vehicle Exhaust Emissions and Fuel Consumption with the use of a JetStar™ Hydrogen Gas Generator. Environment Canada, ERMD Report No International Journal of Scientific & Engineering Research, Volume 6, Issue 5, May-2015 ISSN 2229-5518 73 IJSER © 2015 <http://www.ijser.org/IJSE>.