

Phasor Control for frequency regulation of Converter Response Voltage

Vidyadhar¹, Jharana Behera²

^{*1} Department of Electronics & Communication Engineering, Gandhi Engineering College, Odisha, India

² Department of Electronics & Communication Engineering, Gandhi Institute For Technology, Odisha, India

ABSTRACT: The synchronizing torque of power system is also weakened by increasing installation of static power converters in the course of renewable energy resources because they want to trade their favorable active power by synchronizing their output voltage with the one at the purpose of common coupling. within the circumstances, an idea of Virtual Synchronous Machine (VSM) is proposed, where the self-commutated power converters are emulating synchronous generators. This paper describes a converter control to contribute to enhancing the synchronizing torque. The proposed control is analogous to the VSM but it simply realizes active power trades among power generation units including converter-based generators by modulating phase angles of their output voltages. Therefore, it can provide an efficient support to manage the system frequency where the entire rated power of the converter-based generators increases the maximum amount because the one among conventional rotating generators sort of a microgrid. This paper especially focuses on its robustness where the amount of converter-based generators is increased or they're dispersed within the power network. The effectiveness is verified by simulation study supported instantaneous values.

Keywords: Self-Commutated Power Converter, Synchronous Generator, VSM, generator, microgrid

I. INTRODUCTION

A conventional power system has been supplied by a lot of synchronous generators. They have kept a good power balance among them by their synchronizing torques. On the other hand, a distributed generator injects its maximum output power by observing the phase angle of the voltages at its coupling point. The power balance

can be kept successfully while the total amount of power generated by the distributed generators is negligible compared to the synchronous generators.

Today, the synchronizing torque of a power system may be weakened by increasing installation of static power converters accompanied by renewable energy resources with a growing demand of high penetration of renewable energies. In a microgrid, batteries are often installed with the renewable energy resources to compensate their fluctuating output power. As a result, a lot of static power converters will be normally installed with traditional synchronous generators. In case that the total rated power of the converters exceeds the one of synchronous generators, it is afraid that the synchronizing torque of the microgrid may be spoiled. In the circumstances, there is a proposal of a Virtual Synchronous Machine (VSM) [1]-[3], where the converter behaves like a traditional synchronous machine with the inertia. In recent literatures, the effectiveness of the VSM is evaluated as compared to the traditional droop controller [4] and its dynamic performance is also analyzed [5]. Assuming that the converter is supported by an ideal dc voltage source and consists of ideal semiconductor devices, the VSM can be realized to be equipped with a swing equation onto its controller. The effectiveness is promised by the designed swing equation under an assumed system condition. However, it may be difficult to achieve the same effect when the power system condition is continuously modified according to the increasing installation of the renewable energy resources.

In the circumstances, unlike the VSM, authors proposed a phase-shifting method of the output voltage phasor[6], which simply only emulates an active power exchange between the power converter and the power system to enhance the synchronizing torque of the power system. In the traditional converter control, the output voltage phasor is determined to be synchronized with the terminal voltage at the point of common coupling as described above. On the other hand, the infinite bus voltage can be considered as a voltage phasor with the frequency fixed to its rated value. In the proposed control strategy, each converter independently determines its output voltage phase angle between the two phasors using single control gain and the amplitude of the output voltage is decided by a reactive power control in order to reduce inverter output currents. The control gain can regulate its contribution level, according to its surplus capacity of the converter or energy storage. This is the reasons why the proposed control can be an autonomous control system and it has robustness where the converters continue to be installed increasingly. Therefore, it can provide an effective support to regulate the system frequency where the total rated power of the converter-based generators increases as much as one of the conventional rotating generators like a microgrid.

However, it can be hardly estimated where the available converters are installed and how many inverters join the frequency regulation. Therefore, such control strategy is required to be useful under uncertain conditions. In the proposed control, each converter can share the task automatically in accordance with the electrical distance among the generation units and, if it is overtasked, it can reduce the task by modulating the control gain. This paper explains the behaviors of multiple power converters equipped with the proposed control and verifies its operating characteristics discussed above by simulation study based on instantaneous values. Especially, it is confirmed that multiple static power converters employing the proposed controller can properly cooperate with each other when they are distributed or they use other control parameters.

II. CONVERTER CONTROL FOR COOPERATION WITH A SYNCHRONOUS GENERATOR

2.1. Phase Angle Regulation for Active Power Control

In order to consider an active power interaction between a synchronous generator and a static power converter, a simple system model is used in this paper, as shown in **Figure 1**. For the simplicity, the synchronous generators and the converters are represented by single ones, respectively. V_g and V_c represent the fundamental components of terminal voltages at the synchronous generator and the converter and their phase angles are represented by θ_g and θ_c , respectively. The terminal voltage of the synchronous generator is regulated by a traditional Automatic Voltage Regulator equipped with the generator.

Generally, the self-commutated static power converter regulates its output voltage based on the phase angle of the terminal voltage at the point of common coupling. It detects the phase angle of the terminal voltage at the coupling point θ_t and decides its output voltage. Therefore, the converter follows the frequency regulated by the synchronous generator and trades its favorable output power. Assume that the initial value of the converter phase angle is θ_{c0} , the converter phase angle θ_c can be determined as:

$$\theta_c = \theta_{c0} + \int \omega_g dt, \quad (1)$$

Figure 1. A model with a synchronous generator and a self-commutated static power converter.

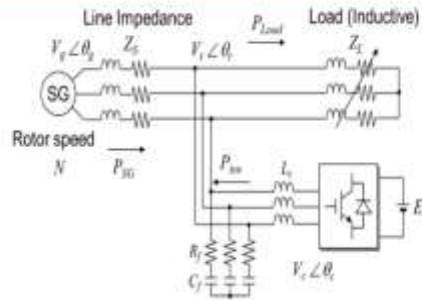

where ω_g is the angular velocity of the synchronous generator. In this case, the converter can be considered as a synchronous machine whose inertia is zero.

On the other hand, the infinite bus has an infinite inertia and a constant voltage. If there is an ideal self-commutated converter with an ideal energy source, it can realize the infinite bus and it is quite stable all through the operation of the microgrid. In this case, the converter phase angle can be represented by the nominal value of the

angular velocity ω_0 , as

$$\theta_c = \theta_{c0} + \int \omega_0 dt. \quad (2)$$

The synchronous generators trade their power after a disturbance and keep a stable cooperation in a power system. The power trade is realized by the difference of the phase angle between them. From this viewpoint, the power trade can be realized by modulating the phase angle of the converter.

Figure 2 summarizes relationships among voltage phasors. Assume that a small disturbance makes the phase angle of the synchronous generator θ_g lag behind the reference angle θ_0 by $\Delta\theta$. When the converter is operated in the traditional operating mode, the voltage phasors can be indicated as **Figure 2(a)**. On the other hand, the converter is operated as shown in **Figure 2(b)** in case that the converter acts as an infinite bus voltage.

Therefore, this paper proposes that the output voltage phasor is placed as shown in **Figure 2(c)**, in order to enhance the synchronizing torque of the power system.

To set the voltage phasor as shown in **Figure 2(c)**, the converter phase angle θ_c is determined as

$$\theta_c = \theta_{c0} + \theta_g + k_c (\theta_0 - \theta_g), \quad (3)$$

$$0 \leq k_c < 1. \quad (4)$$

The phase angle of the converter θ_c can be increased to lead θ_0 by $\Delta\theta$ this case, the angular velocities can be formulated by

$$\int (\omega_c - \omega_0) dt = \int (\omega_0 - \omega_g) dt. \quad (5)$$

Therefore, the phase angle θ_c can be derived as

$$\theta_c = \theta_{c0} + \int (2\omega_0 - \omega_g) dt. \quad (6)$$

However, Equation (6) can be represented by substituting 2.0 to k_c of Equation (3). Therefore, all operating modes can be represented as **Figure 2** with different value of k_c .

2.2. Amplitude Modification for Reactive Power Control

In order to reduce the converter rated current, reducing the reactive power output is effective. Therefore, the voltage phasor amplitude is regulated in addition to the phase angle control.

Figure 3(a) is a simple equivalent circuit when a self-commutated power converter is interconnected to a power system with a linkage inductance X_L . V_t represents the output voltage of the converter and V_{grid} is the voltage at the coupling point. By the phase angle difference δ between V_t and V_{grid} , voltage phasors can be indicated as shown in **Figure 3(b)**. In this case, the converter trades active and reactive power as:

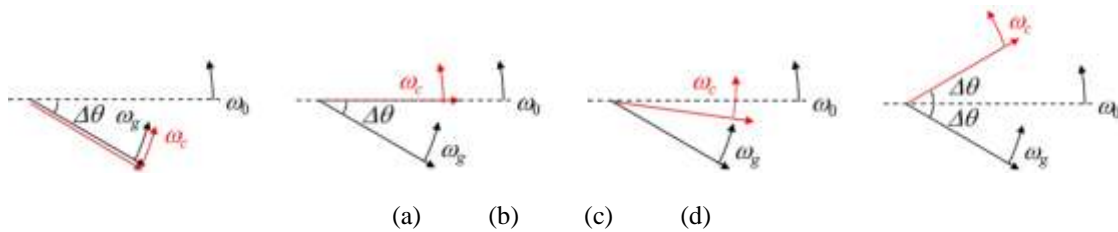

Figure 2. Various placements of the converter output voltage phasors. (a) $k_c = 0.0$, (b) $k_c = 1.0$, (c) $0.0 < k_c < 1.0$, (d) $k_c = 2.0$.

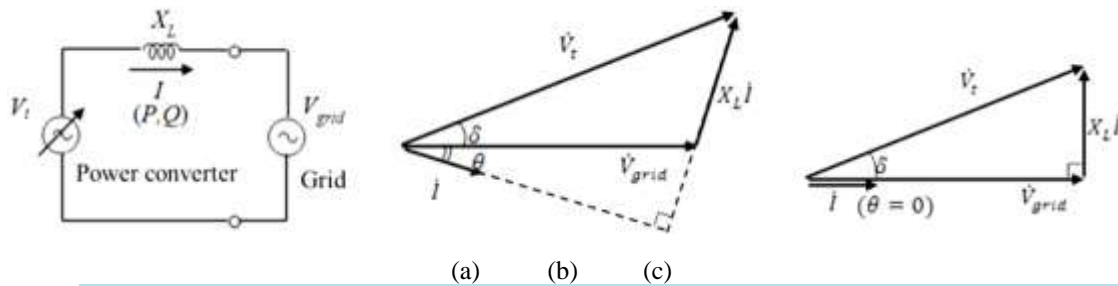

Figure 3. Reactive power regulation of the converter. (a) A simplified equivalent circuit, (b) Phase-shifted output voltage phasors, (c) Regulated output voltage phasor.

$$P = V_{grid} I \cos\theta, \quad (7)$$

$$Q = V_{grid} I \sin\theta. \quad (8)$$

Considering the relations among the voltage phasors as shown in **Figure 3(b)**,

$$X_L I \cos \theta = V_t \sin \delta , \quad (9)$$

$$X_L I \sin \theta = V_t \cos \delta - V_{\text{grid}} . \quad (10)$$

Therefore, the active and reactive power can be formulated as

$$P = \frac{V_t V_{\text{grid}}}{X_L} \sin \theta , \quad (11)$$

$$Q = \frac{(V_t V_{\text{grid}} \cos \delta - V_{\text{grid}}^2)}{X_L} . \quad (12)$$

Assumed that the reactive power Q is equal to zero, the following equation can be derived from Equation

$$V_t = \frac{V_{\text{grid}}}{\cos \delta} . \quad (13)$$

By detecting the phase angle of the voltage V_{grid} , δ can be achieved. Then, the reactive power can be equal to zero by keeping the relation of Equation (13).

2.3. Proposed Voltage Phasor Controller

The output voltage controller consists of the above two concept as shown in **Figure 4**. First, the phase angle of the voltage is determined and then its amplitude is modified based on the reactive power control. The proposed control is equipped with a sinusoidal wave generator and the well-known triangular-wave Pulse Width Modulation of a three-phase voltage sourced converter, as shown in **Figure 4**.

It should be noted that the reference angle is ordinary determined by the traditional method such as normal PLL. When the converter controller detects a large frequency variation beyond its prescribed threshold value, the proposed controller slightly shift its reference angle by this method.

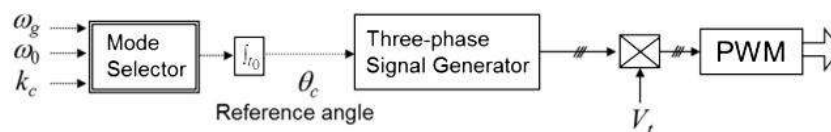

Figure 4. Output voltage controller of the converter.

III. SIMULATION RESULTS WITH SINGLE INVERTER UNIT

The proposed control is verified by simulation study. A system model shown in **Figure 1** is used with the para-meters summarized in **Table 1**. The dc side voltage of the converter is assumed to be supported by ideal dc vol-tage source. On the other hand, the traditional rotating synchronous machine is represented by a Motor-and-Generator combination which employs a speed governor and an automatic voltage regulator.

In the actual system, it may be difficult to detect the frequency of the center of inertia. For the simplicity, the referential frequency is assumed to be detected by the rotor speed of the rotating generator in this paper.

When $k_c = 0.5$, **Figure 5** shows how the frequency and active power output of synchronous generator and power converter behaves after the load variation. It can be confirmed in the upper figures that the controller set the frequency reference as a half of system frequency.

If the control gain is adjusted, the effectiveness of the controller can be modified as shown in **Figure 6**. When $k_c = 0.0$, the active power output of the converter immediately recovered to the initial value and it does

not contribute the frequency regulation. However, increasing k_c enhances the control effect as shown in **Figure 6**.

From these results, the proposed controller can adjust its control effect by simply modifying the single control gain k_c .

IV. CONTROL EFFECT BY MULTIPLE CONVERTERS

When the proposed controller is applied to multiple power converters, their parameters can be designed independently. **Figure 7** shows a model system with two power converters which are equipped with the proposed control. The control gains K_1 and K_2 are defined to adjust their contributions to frequency regulation. **Table 2** summarizes simulation conditions.

First, same circuit parameters are given to the two converters, which are indicated as the Case 1 in **Table 2**, but different control gains K_1 and K_2 are applied to them. **Figure 8** displays simulation results, comparing with the different control gains. As shown in **Figure 8(a)**, same control gains result in the same behaviors, where the same active powers are injected and both reactive powers are regulated as zero.

On the other hand, different control gains introduce different behaviors as shown in **Figure 8(b)**. There is no difference in the frequency variations of the two cases because the values of $K_1 + K_2$ are same. However, two converters show different contributions after the load variation. The converter 2 with the larger control gain outputs high active power, resulting in the high contributions to the frequency regulation.

Therefore, it is confirmed that the contribution to the frequency regulation can be simply adjusted by the control gain.

Figure 9 shows simulation results in Case 2, where the different circuit parameters are used as indicated in **Table 2**. The different linkage inductance implies that they are not installed at the same point but distributed in a power network. However, as the proposed control directly modifies the phase angle of the output voltage of the converter, the output active power is influenced by the interconnecting inductance. Therefore, although the same control gains are used in the proposed controller in the case of **Figure 9(a)**, the output active power of the converter 2 is larger than the one of the converter 1. In addition, if the control gain of the converter 2 is changed to the larger one, the output active power is increased as shown in **Figure 9(b)**.

The two converters are connected at the same coupling point as indicated in **Figure 7**, but the interconnecting inductance means the electrical distance from the coupling point. Therefore, **Figure 9(a)** also indicates that the converter which is near the generator contributes well to the frequency regulation.

Table 1. Conditions for simulation study.

Microgrid	
Operating frequency f_0	60 Hz
Rated RMS voltage (3 ϕ , line-to-line)	200 V
Line impedance Z_S	0.10 Ω , 6.0 mH
Load (inductive) Z_L ($t < 2.5$ s)	2.4 Ω , 2.1 mH
(2.5 s $< t$)	1.6 Ω , 2.1 mH
Converter	
Dc voltage source E_d	400 V
Interconnecting Inductance L_c	5.0 mH
Ac filter capacitor C_f	6.0 μ F
Switching frequency	3 kHz

Table 2. Conditions for simulation with two converters.

System parameters		
Rated voltage (3 ϕ , line-to-line)		200 V
Operating frequency f_0		60 Hz
Line impedance Z_s		0.10 Ω , 5.0 mH
Load (inductive) Z_L (t < 2.5 s)		2.4 Ω , 2.1 mH
(t > 2.5 s)		1.6 Ω , 2.1 mH
Converter 1, 2		
	Case 1	Case 2
Dc voltage source E_{d1}, E_{d2}	400 V	400 V
linkage inductance L_{c1}, L_{c2}	5.0 mH	5.0 mH, 3.0 mH
Ac filter capacitor C_{f1}, C_{f2}	6 μ F	6 μ F, 11 μ F
Switching frequency f_{s1}, f_{s2}	3 kHz	3 kHz

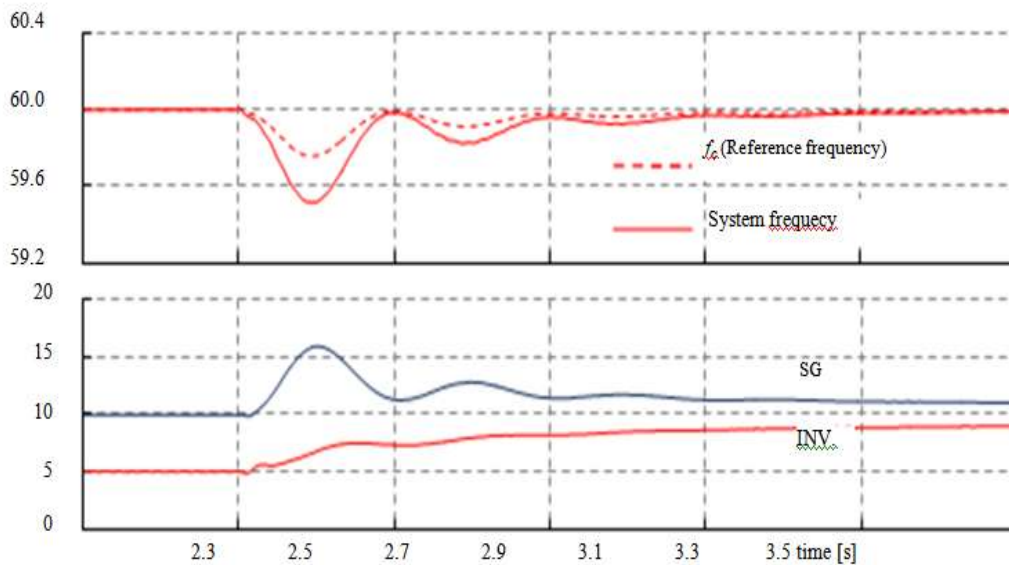

Figure 5. Frequency and active powers after a load variation when $k_c = 0.5$.

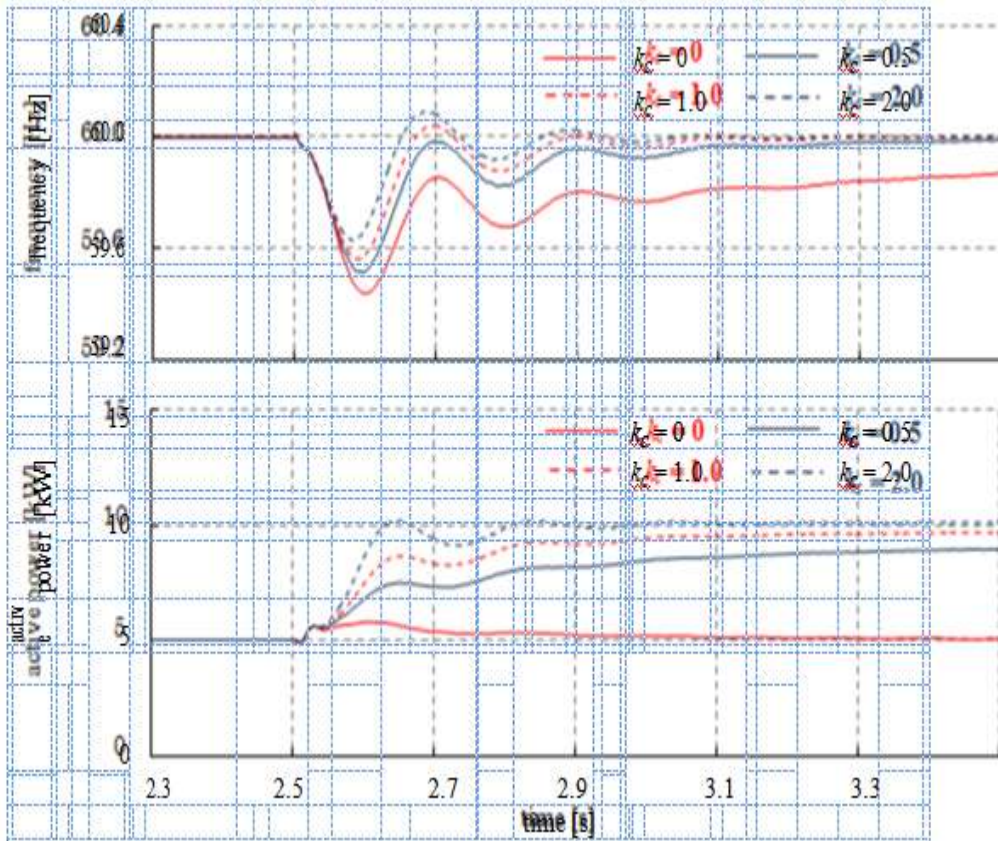
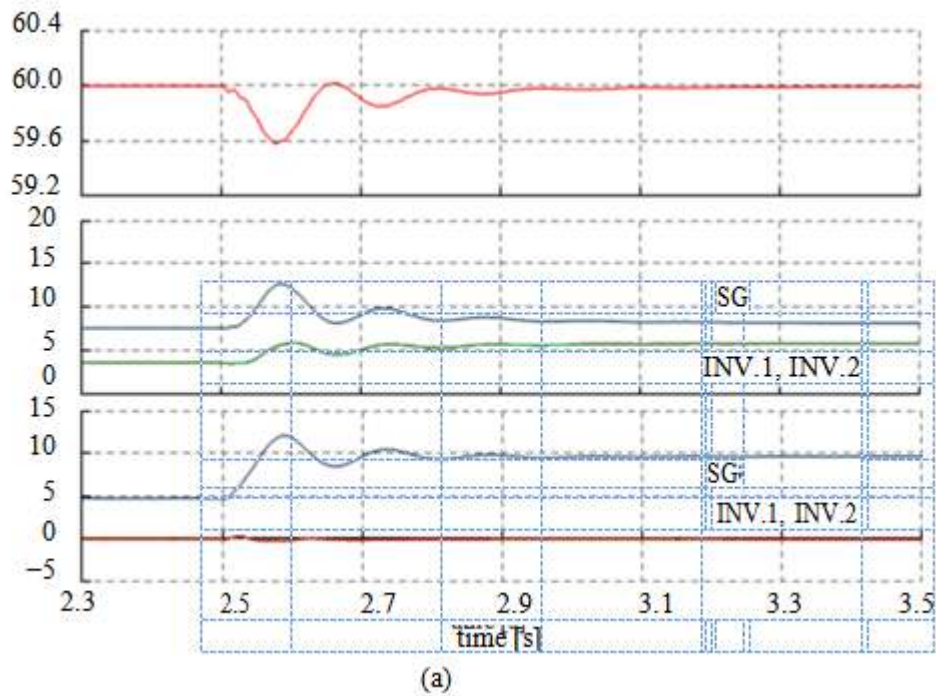
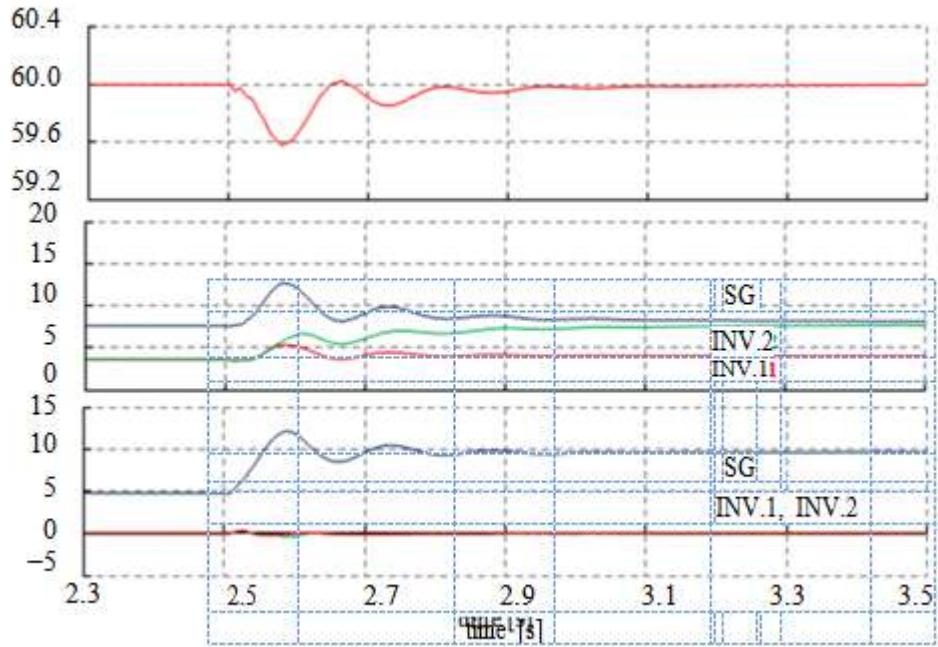

Figure 6. Comparisons of frequency and active powers with different gain k_c .





(b)

Figure 8. Simulation results when the same linkage inductances and filter ca-pactors are used (Case 1). (a) $K_1 = K_2 = 1/2$, (b) $K_1 = 1/4$, $K_2 = 3/4$.

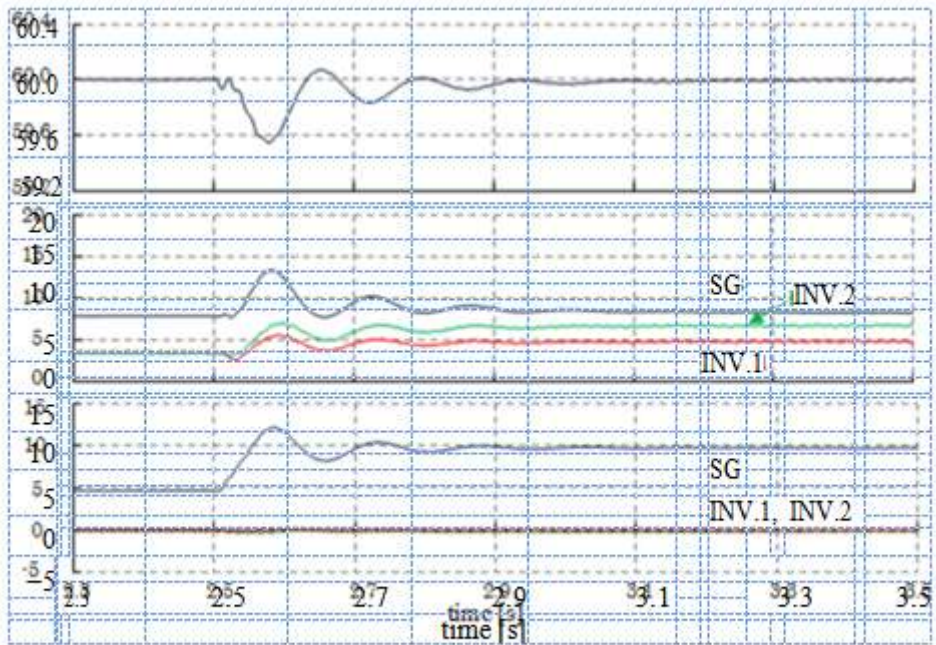

(a)

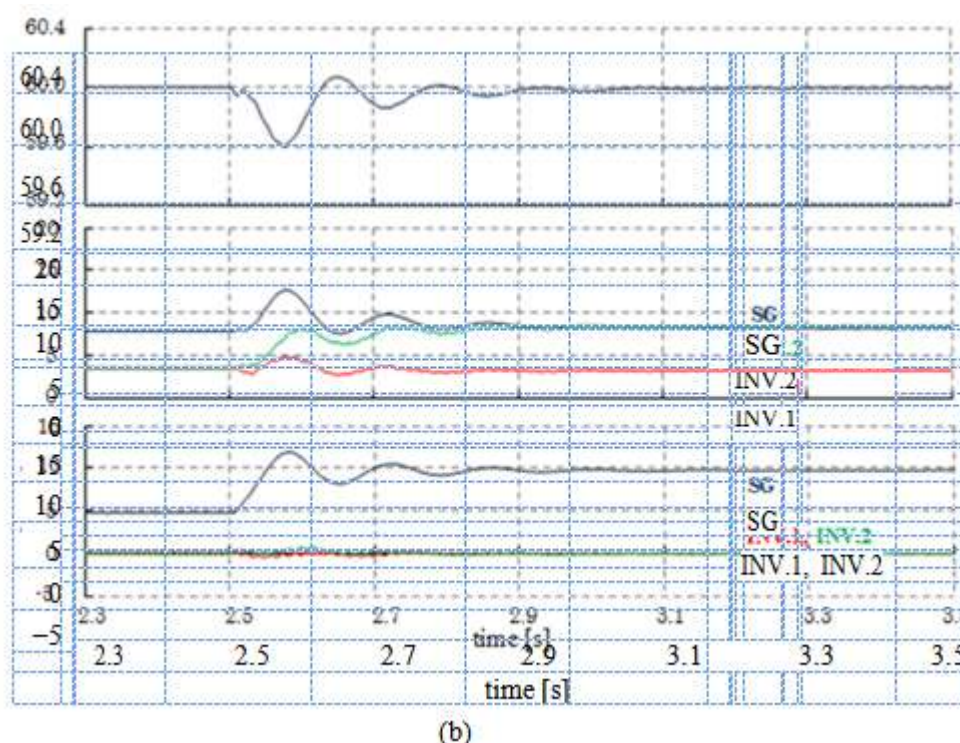

Figure 9. Simulation results when different linkage inductances and filter ca-pactors are used (Case 2). (a) $K_1 = K_2 = 1/2$, (b) $K_1 = 1/4$, $K_2 = 3/4$.

V. CONCLUSION

This paper proposed a simple converter controller to contribute to the system frequency regulation. The converter control emulating the power trade between the synchronous machines is developed and equipped to the static power converter. The effectiveness of the controller is tested by simulation study in case of a small disturbance like a load variation. In the simulation study, it is confirmed that the contribution of the converter can be easily adjusted by the single control gain. In addition, the controller can be also tested when multiple converters employ it. By the detailed simulation, the two converters share the role of the frequency regulation, according to their control gains or the electrical distance among the generation units. From these results, the proposed controller can be easily applied to the power converter such as being used for renewable energy resources with some amount of energy storage, resulting in enhancement of frequency regulations.

REFERENCES

- [1] Beck, H.P. and Hesse, R. (2007) Virtual Synchronous Machine. International Conference on Electrical Power Quality and Utilization, Barcelona, 9-11 October 2007, 6 p.
- [2] Visscher, K. and Haan, S.W.H. (2008) Virtual Synchronous Machines (VSG's) for Frequency Stabilization in Future Grids with a Significant Share of Decentralized Generation. CIRED Seminar 2008: Smart-Grids for Distribution, Frankfurt, 23-24 June 2008, 0118.
- [3] Sakimoto, K., Sugimoto, K. and Shindo, Y. (2013) Low Voltage Ride through Capability of a Grid Connected Inverter Based on the Virtual Synchronous Generator. Proceedings of the IEEE 10th International Conference on Power Electronics and Drive Systems, Kitakyushu, 22-25 April 2013, 1066-1071.
- [4] Alipoor, J., Miura, Y. and Ise, T. (2014) Voltage Sag Ride-Through Performance of Virtual Synchronous Generator. Proceedings of the 2014 International Power Electronics Conference—ECCE, Hiroshima, 18-21 May 2014, 3298-3305.
- [5] Liu, J., Miura, Y. and Ise, T. (2014) Dynamic Characteristics and Stability Comparisons between Virtual Synchronous Generator and Droop Control in Inverter-Based Distributed Generators. Proceedings of the 2014 International Power Electronics Conference—ECCE, Hiroshima, 18-21 May 2014, 1536-1543.
- [6] Hojo, M., Ikeshita, R., Terauchi, T., Ueda, Y. and Funabashi, T. (2011) A Converter Controller of Virtual Synchronous Machine for Stable Operation of Microgrid. Conference Proceedings of 21th International Conference and Exhibition on Electricity Distribution (CIRED), Frankfurt, 6-9 June 2011, 0535.